

3. Binary and M-ary Digital Communication Techniques

3.1 Error probability computation

We will first consider the "antipodal" and "orthogonal" binary signal sets and the performance bounds of Digital Communication Systems. Then we will extend this to "multi-level" signal sets to study, in particular, the QAM, QPSK, MPSK and other signaling cases. We will also present architectures for some of these systems.

- Binary Antipodal Signals. In general, two signal vectors each with probability 1/2 can be any two points in space as shown below.
- From the performance (in terms of BER) signal configurations can be rotated and translated such that the centroid coincides with the origin of the coordinate system and the results are identical.

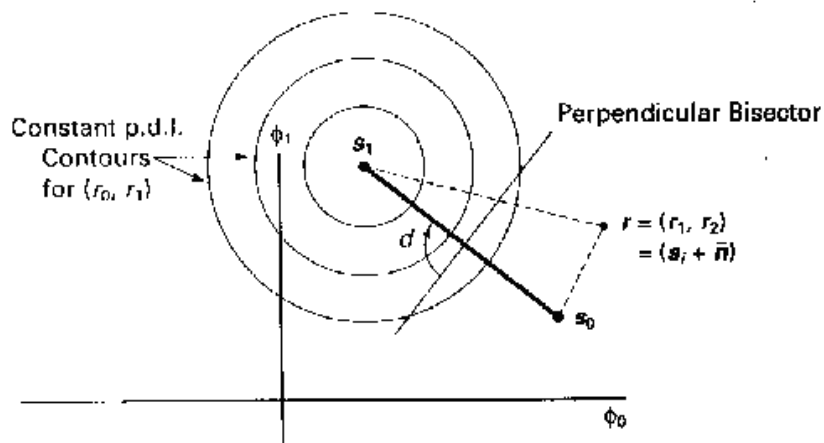

Figure 3.1 Signal-space geometry for generic binary detection.

- Optimal receiver for two equiprobable signals is a 2-channel correlator or 2-matched filters. However, we can realize the same decision by use of the receiver below, which correlates with the *Difference Signal*: $s_0(t) - s_1(t)$. If the energies are not equal, we add a D.C. bias as shown or adjust the decision threshold.

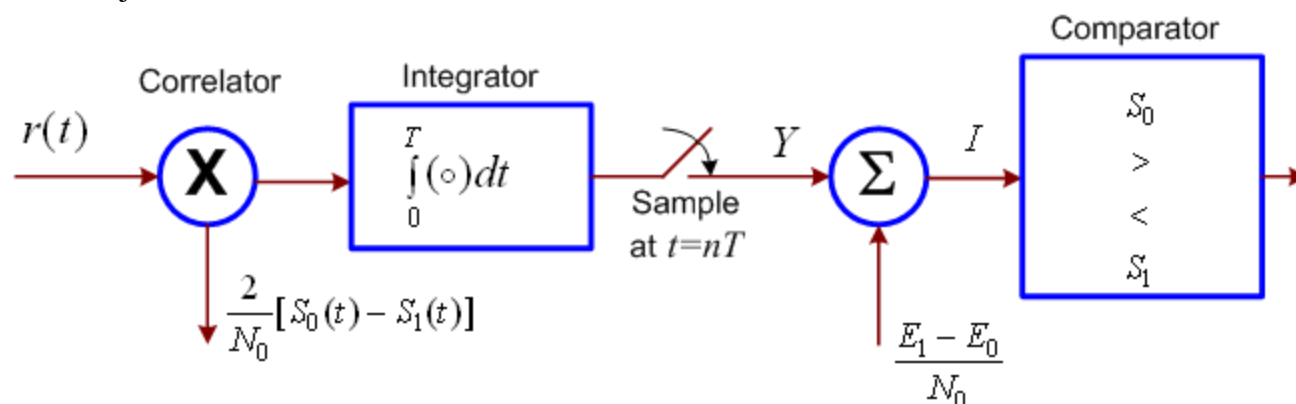

Figure 3.2 Optimal Binary Correlation Receiver with a single integrator.

1. Mean of the random variable at the output of the correlator:

$$\mathbf{m}_0 = E\{Y | s_0\} = \frac{2}{N_0} \int s_0(t)[s_0(t) - s_1(t)]dt \quad (3.1)$$

$$\mathbf{m}_1 = E\{Y | s_1\} = \frac{2}{N_0} \int s_1(t)[s_0(t) - s_1(t)]dt \quad (3.2)$$

2. The difference between the two means is:

$$\Delta \mathbf{m} \equiv \mathbf{m}_0 - \mathbf{m}_1 = \frac{2}{N_0} \int [s_0(t) - s_1(t)]^2 dt = E_d \frac{2}{N_0} \quad (3.3)$$

where E_d is the energy in the difference signal.

3. Variance of the decision variable:

$$\mathbf{s}^2 = Var\{\int [s_0(t) - s_1(t)]n(t)dt\} = E_d \frac{N_0}{2} \quad (3.4)$$

the last equality is due to the fact that noise is White Gaussian and S.I. with the signal set. The conditional pdfs for general binary detection is depicted as two Gaussian probabilities centered at respective mean values:

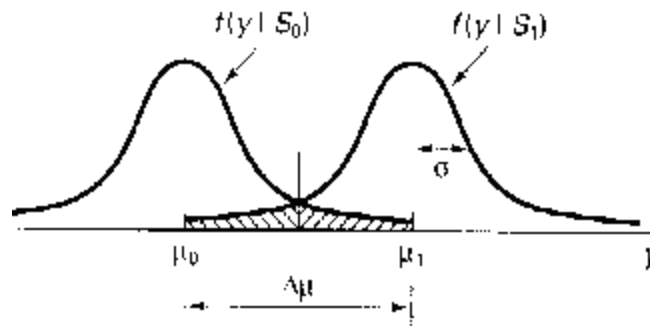

Figure 3.3 Conditional p.d.f for generic binary detection and error regions.

4. Optimal threshold is the midway between the two means and a BER occurs if decisions fall into Gaussian tails above.
5. Error probability is simply the Gaussian tail integral defined in terms of Q function in Chapter 1.:

$$P(\mathbf{e} | s_0) = Q\left(\frac{\Delta \mathbf{m}}{2\mathbf{s}}\right) = Q\left([E_d / 2N_0]^{1/2}\right); \quad (3.5a)$$

$$P(\mathbf{e} | s_1) = Q\left([E_d / 2N_0]^{1/2}\right) \quad (3.5b)$$

6. The total BER for a general binary digital communication system is finally given by:

$$P(\mathbf{e}) = Q\left([E_d / 2N_0]^{1/2}\right) \quad (3.6)$$

7. From the Figure 3.1, we see that the only component of noise vector harmful to the decision process is that component in the direction along the line connecting s_0 and s_1 . By symmetry, this component is also zero-mean with variance $\mathbf{s}^2 = N_0 / 2$. If this noise variable is more positive than $d / 2$ then an error occurs:

$$P(\mathbf{e} | s_0) = \frac{1}{(2\pi N_0 / 2)^2} \int_{d/2}^{\infty} e^{-\frac{n^2}{N_0}} dn = Q\left(\frac{2d}{\sqrt{2N_0}}\right) \quad (3.7)$$

From symmetry, we have:

$$P(\mathbf{e}) = Q\left(\frac{2d}{(2N_0)^{1/2}}\right) = Q\left(\left[\frac{2d^2}{N_0}\right]^{1/2}\right) \quad (3.8)$$

3.2 Antipodal Binary Signaling

If we choose the signaling design such that $s_1(t) = -s_0(t)$ with equal energy: $E_s = E_1 = E_0$ and $d = 2\sqrt{E_s}$, we have the **final Bit Error Rate (BER) for Antipodal Binary Signaling**:

$$BER_{antipodal} = P(\mathbf{e}) = Q\left(\sqrt{\frac{2E_s}{N_0}}\right) \quad (3.9)$$

Example: Several different antipodal designs with varying degree of simplicity are shown below:

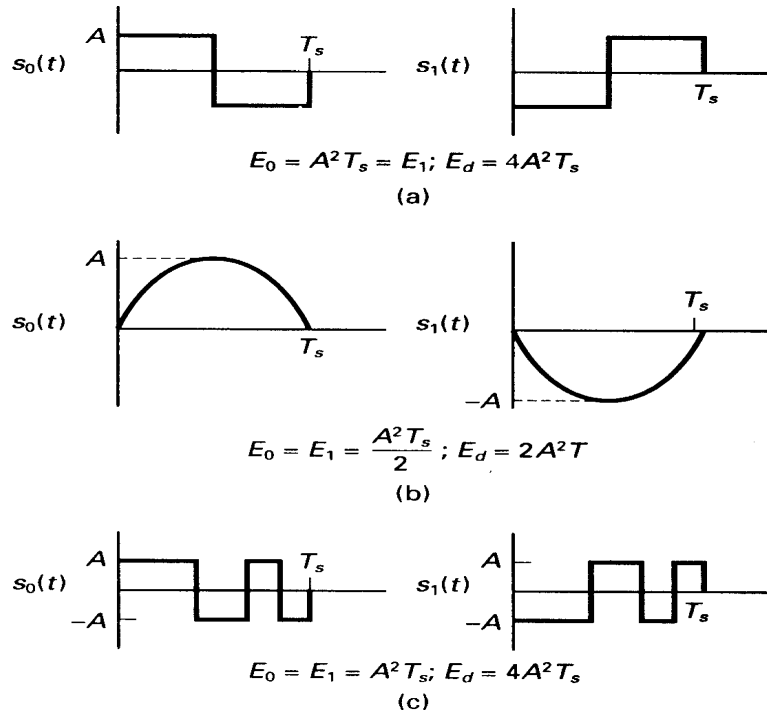
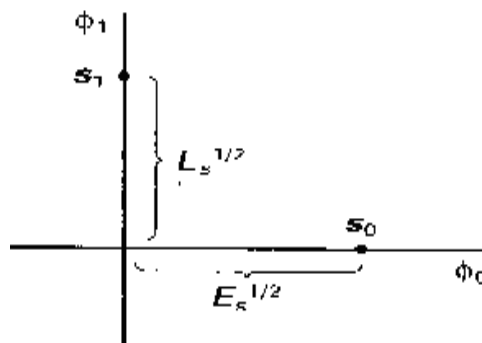

Figure 3.3.12 Examples of antipodal signals. (a) Manchester, or split-phase; (b) half-cycle sinusoid; (c) spread spectrum signals.

3.3 Binary Orthogonal Signaling

The signals or the codewords are placed at each orthogonal axis as shown below. Both signals along two different axes have the same energy, but the distance between them is only $d = \sqrt{E_{s_1} + E_{s_0}} = (2E_s)^{1/2}$ due to triangle law. This slightly effects the BER:

$$BER_{binary\ orthogonal} = P(\mathbf{e}) = Q\left(\sqrt{\frac{E_s}{N_0}}\right) \quad (3.10)$$



Example: Two sample waveforms consisting of Pulse Position Modulation (PPM) and FSK are shown below:

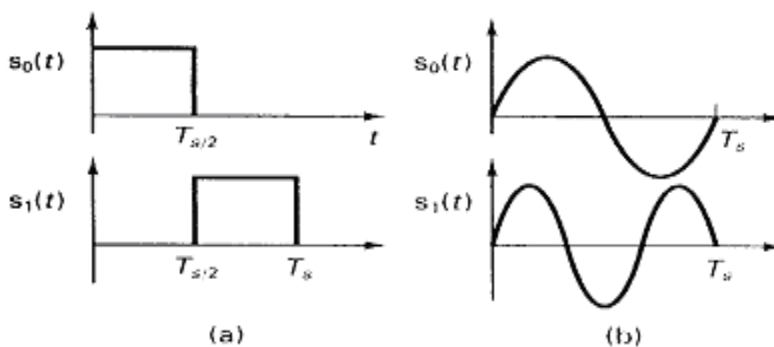

BER or Probability of error comparison of these two alternatives are shown below:

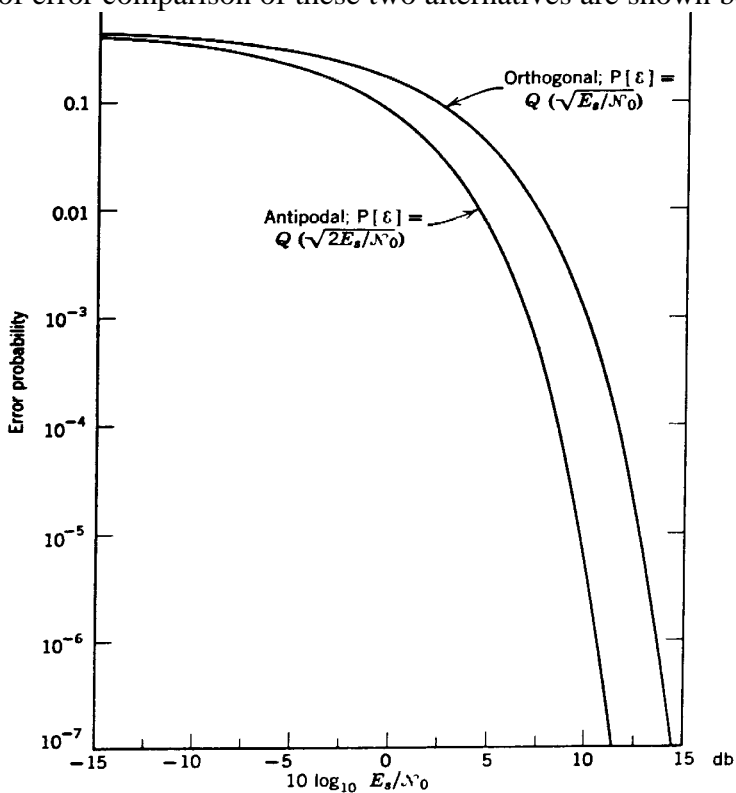

Figure 4.31 Probability of error for binary antipodal and binary orthogonal signaling with equally likely messages.

3.4 ML Receivers for Bi-Orthogonal (4-PSK) and Multilevel (QAM) Signals

Below we have two popular constellations for passband PAM transmission, samples from their received signals in an AWGN regime and the optimal decision regions, respectively, where the constants \mathbf{b} and \mathbf{c} are related to power in each case.

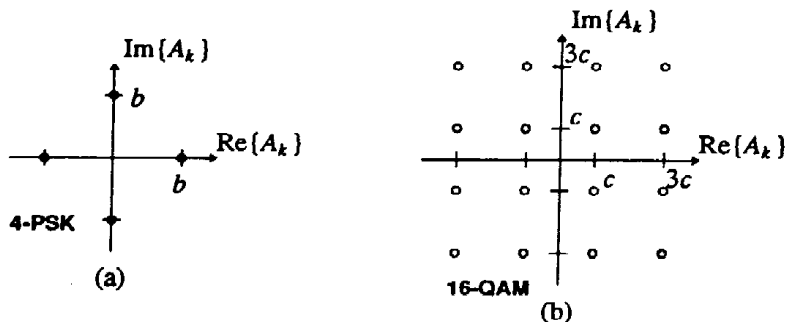

Figure 6-24. Two popular constellations for passband PAM transmission. The constants b and c affect the power of the transmitted signal.

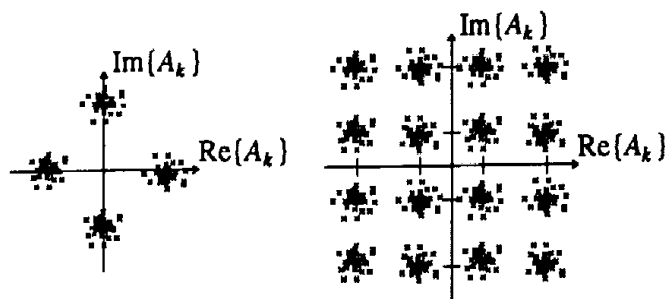

Figure 6-25. Received samples perturbed by additive Gaussian noise form a Gaussian cloud around each of the points in the signal constellation.

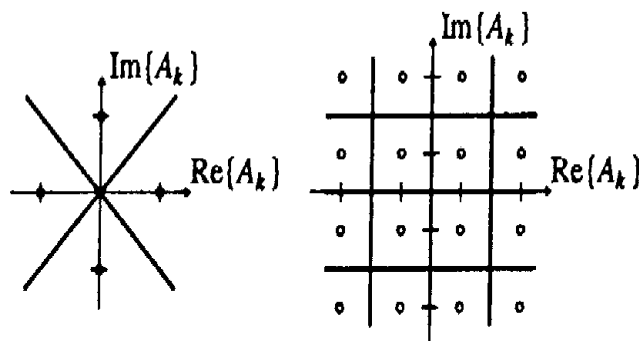

Figure 6-26. The ML detectors for the constellations in Figure 6-24 have the decision regions shown.

3.5 Performance Bounds on Message Sets with Equal Probability in AWGN

Assume that the message set has M letters in its alphabet and they are equally probable; AWGN PSD level is N_0 ; the nearest neighbor distances between \underline{S}_i and its nearest-neighbor (NN) is given by $\{d_{\min_i}\}$.

Binary error probability has a lower bound:

$$P(\mathbf{e}) \geq \frac{1}{M} \sum_{i=0}^{M-1} Q\left(\frac{d_{\min_i}}{\sqrt{2N_0}}\right) \geq Q\left(\frac{d_{\min}}{\sqrt{2N_0}}\right) \quad (3.11)$$

Similarly, the upper bound for this error probability is found by using the "Union Bound Theorem" as:

$$P(\mathbf{e}) \leq \frac{1}{M} \sum_{i=0}^{M-1} \sum_{i \neq j} Q\left(\frac{d_{ij}}{\sqrt{2N_0}}\right) \quad (3.12)$$

where d_{ij} is the distance between i^{th} and j^{th} signal locations in the N -dimensional space. For the i^{th} signal, the inner sum is bounded by $M-1$ times the largest term of the sum, which occurs when, d_{ij} is minimum over j . This results in:

$$P(\mathbf{e}) \leq \frac{M-1}{M} \sum_{i=0}^{M-1} Q\left(\frac{d_{\min_i}}{\sqrt{2N_0}}\right) \leq (M-1)Q\left(\frac{d_{\min}}{\sqrt{2N_0}}\right) \quad (3.13)$$

The last inequality is the case for all d_{\min_i} are equal distances by symmetry. The difference between (3.11) and (3.13) is a multiplier $(M-1)$. For fairly small M these two bounds are rather tight but they get looser if M is large. Let us plot the performance as a function of normalized signal-to-noise ratio, where:

$$E_s / N_0 = \left(\frac{E_b}{N_0}\right) \cdot \log_2(M) \quad (3.14)$$

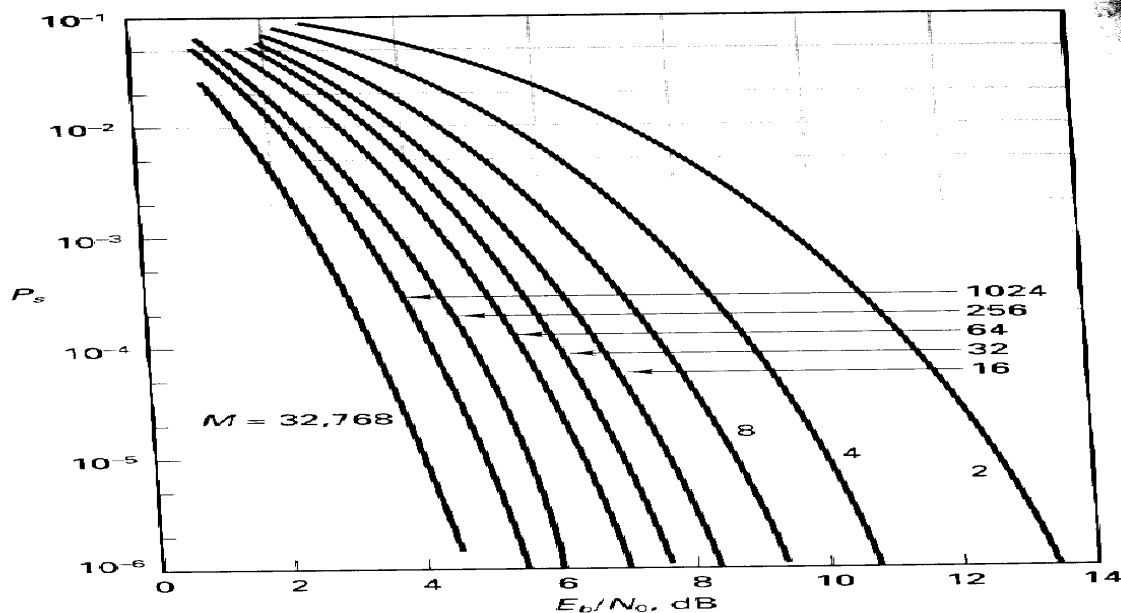

Figure 3.3.17 Symbol error probability for coherent detection of orthogonal signals.

Example: M-ary Signal Constellation Designs.

1. Bi-orthogonal and Optimal Sphere Packing (Hexagonal) Constellations:

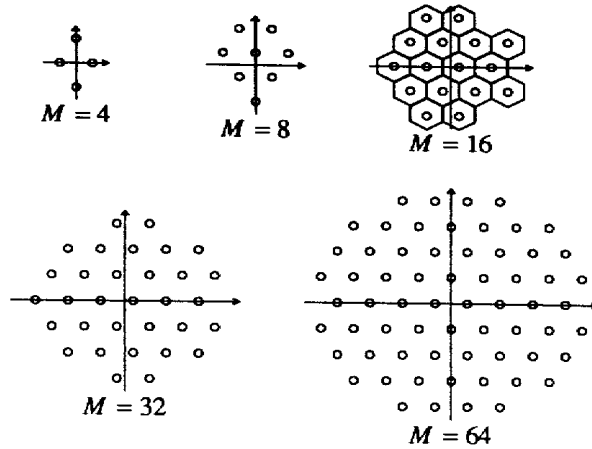
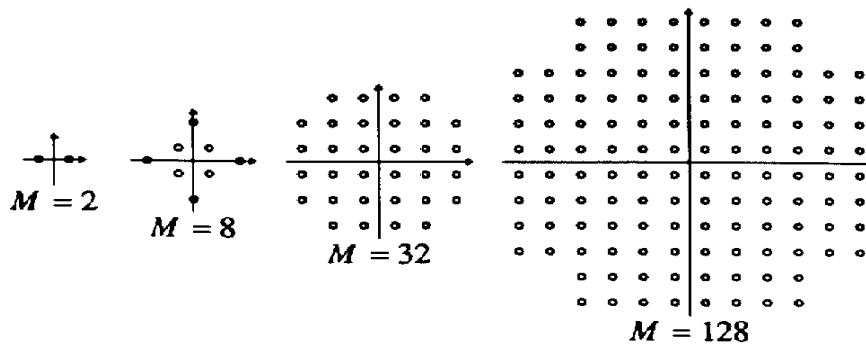

Figure 6-30. Optimal hexagonal constellations. For the $M = 16$ constellation we have shown the hexagonal decision regions. The outer decision regions are approximated as hexagonal for uniformity.

2. Practical and Common QAM Constellations:



6-28. Cross constellations.

3. PSK and Combined Constellations:

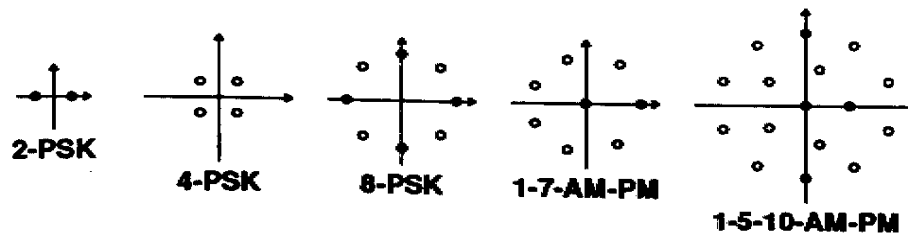

Figure 6-29. Constellations using phase-shift keying and amplitude modulation.

M-ary Bi-orthogonal Designs:

Let us augment the orthogonal signals with their negatives. Thus, we have an M-ary bi-orthogonal set formed as the union of an $(M/2)$ -ary orthogonal set $\{s(t); i = 0, 1, \dots\}$ and its complementary set $\{-s(t); i = 0, 1, \dots\}$.

- Optimum receiver correlates the incoming signal with all the members of either orthogonal set and then finding the signal with the largest magnitude. The sign of this correlation reveals whether the decision should be in favor of an index in the correlating set or an index in the complimentary set as shown below.

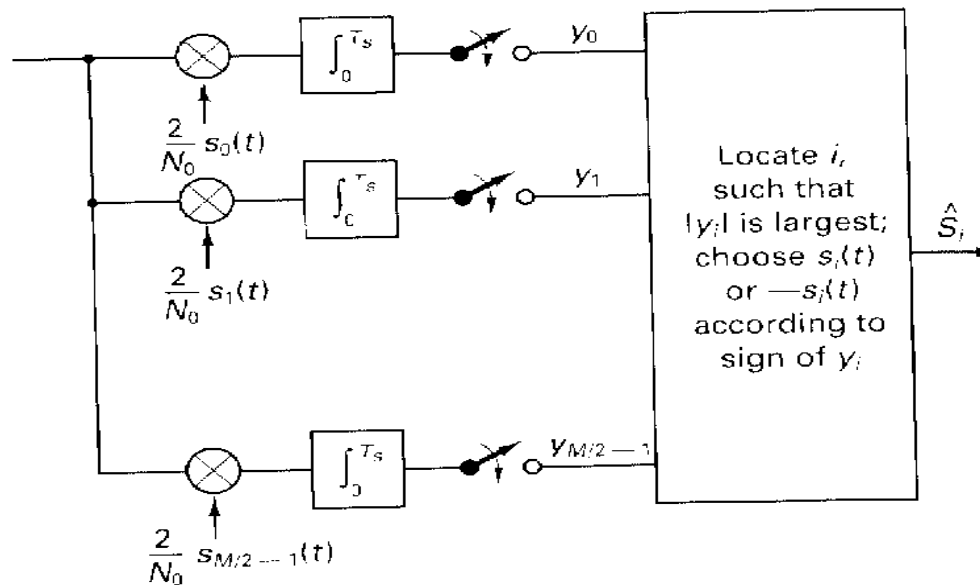
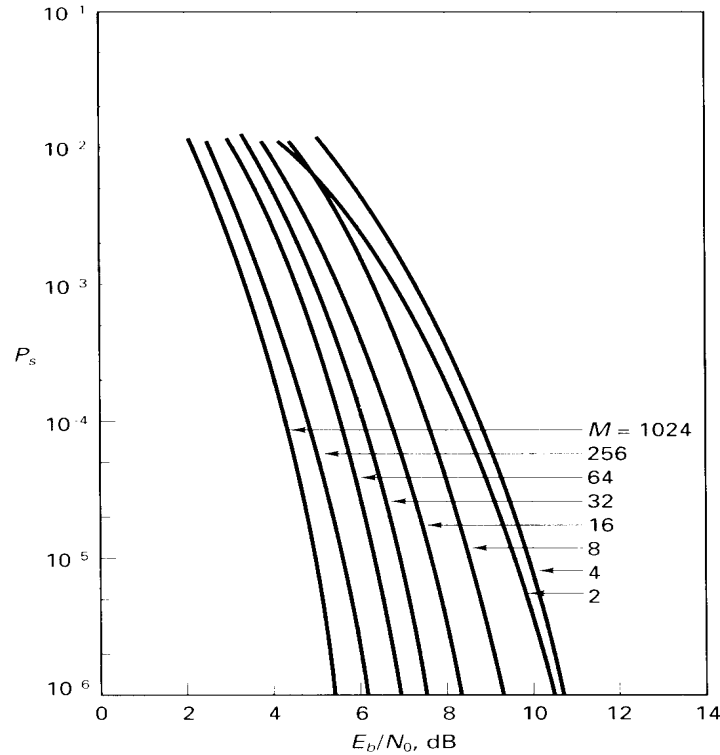

Figure 3.3.18 Biorthogonal receiver (note $M/2$ channels).

- Performance of these receivers: Assume that the message m_o and its signal s_o is sent, the r.v. $\{Y_i\}$ is Gaussian with mean: $\mathbf{m} = 2E_s / N_0$ and identical variances $\mathbf{s}^2 = 2E_s / N_0$. Using the bound in (3.13) the probability of correct decision becomes:

$$P(C) = \int_0^{\infty} \frac{\exp\left[-\frac{(y_0 - \mathbf{m})^2}{2\mathbf{s}^2}\right]}{\sqrt{2p\mathbf{s}^2}} \left[1 - 2Q\left(\frac{y_0}{\mathbf{s}}\right)\right]^{\frac{M}{2}-1} dy_0 \quad (3.15)$$

As expected, this integral is not easy to find a compact result, and hence, it is normally evaluated numerically. Below is the plot of error probability for a number message sizes, M.



- As M increases the energy efficiency improves steadily (or the resulting error probability decreases for a given operational level.)
- Simultaneous observations of the plots for "orthogonal and bi-orthogonal" designs reveal that the latter is superior especially for small M .
- The cost is the need for the receiver to distinguish a signal from its complement.
- This last point implies phase synchronization in carrier modulation schemes.
- Regarding the BER for bi-orthogonal signals, we note that there are two types of error events:
 1. Choosing $-S_0$ instead of S_0 .
 2. Choosing one of the $M-2$ signals orthogonal to S_0 .

Example:

Case for $M=8$ and Fixed: $E_b / N_0 = 5.0 \text{ dB}$.

- Since $E_b / N_0 = 5.0 \text{ dB} = 3.16 \Rightarrow E_s / N_0 = 3.16 \cdot \log_2 8 = 9.48 = 9.80 \text{ dB}$.
- Orthogonal Signaling Curve: $BER = P_s = 6.5 \times 10^{-3}$
- Bi-orthogonal Signaling Curve: $BER = P_s = 5.8 \times 10^{-3}$
- Let us use rectangular pulses for this signaling as shown below:

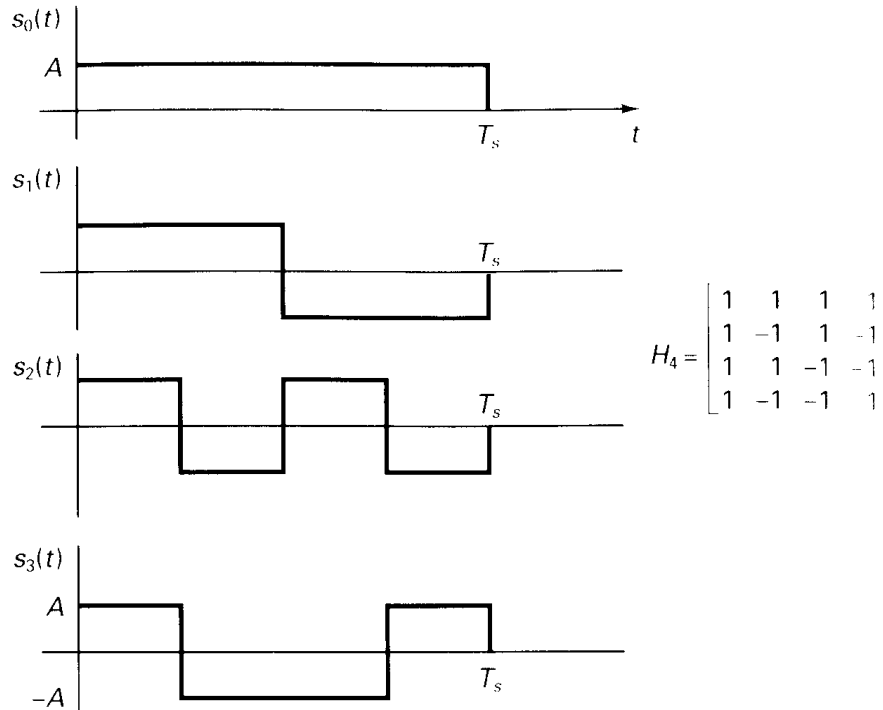

- We can use Hadamard matrices to generate order 8 as an extension of order 4:

$$\underline{H}_8 = \begin{bmatrix} \underline{H}_4 & \underline{H}_4 \\ \underline{H}_4 & -\underline{H}_4 \end{bmatrix} \text{ where } \underline{H}_4 = \begin{bmatrix} \underline{H}_2 & \underline{H}_2 \\ \underline{H}_2 & -\underline{H}_2 \end{bmatrix} = \begin{bmatrix} 1 & 1 & 1 & 1 \\ 1 & -1 & 1 & -1 \\ 1 & 1 & -1 & -1 \\ 1 & -1 & -1 & 1 \end{bmatrix} \quad (3.16)$$

- We choose 8-rows of the Hadamard matrix order-8 similar to shapes in the figure for the 8-ary bi-orthogonal signal set. Note that the first element in all rows is "1" and lends no distinguishability to the signal set and it can be eliminated without loss in performance.
- Benefit is to decrease the energy per bit to 7/8 of the former value.
- Finally, the dimensionality is reduced to "seven", resulting in a need to use "7" non-overlapping pulses as the basis functions.